



MAPPLE **TECHNOLOGY PVT. LTD.**

Mapple Pharma Group of Companies

**Manufacture & Exporter of Pharma & Lab Equipment, Glassware,
Medical Consumables, Surgical Items, Particle Size Analyser, Microscope!!**

PRODUCT GUIDE

Technology for Excellent Results

Gas Equipments / Gas Generators - Gas

Purification Control System

- Gas Piping & Utility Projects
- Gas Generator (High Purity) for Air, Nitrogen & Hydrogen
- Gas Detector & Analyzer

Gas Equipments / Gas Generators - Gas

- Sonicator & HPLC Column Oven
- HPLC Column Washing Pump & Liquid Flow Meter
- N2 Concentrator & Turbo Evaporator
- IR / FTIR Accessories
- Probe Sonicator
- Vacuum Pump
- Digital Gas Flow Meter

Air Sampler / Particle Analyser Microscope
Liquid Particle Analyser

GC / HPLC / Analytical Accessories

- GC & HPLC Column & Syringes / Consumables
- Autosampler Head Space Vials
- Syringe Filters

Medical Equipments & Accessories

Pharma Equipment

Pressure Vessel
SS Tank
Vehicle Ss Tank
SS Beakers
Ss Petri Dish Stand

Acrylic Items

Acrylic Dispenser
Acrylic Box

Many More



GAS PURIFICATION & CONTROL PANEL FOR GC

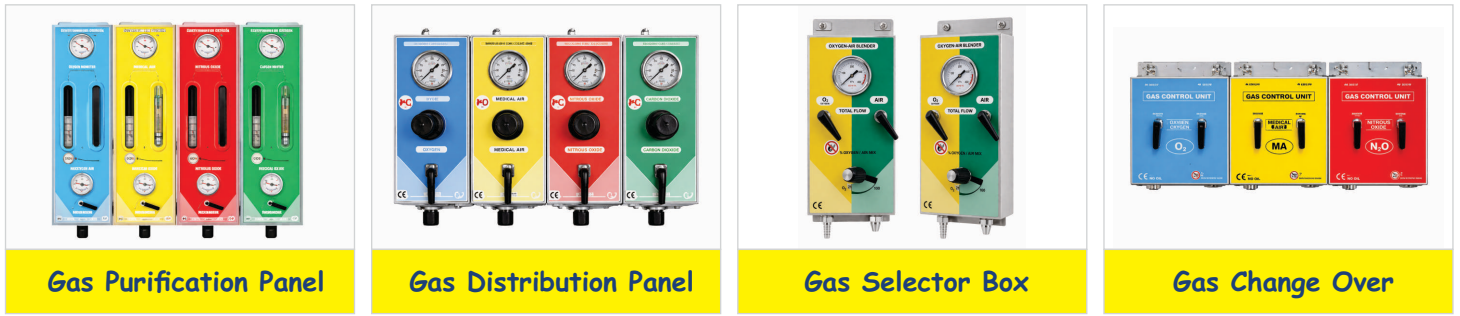

ATTACHMENTS FOR GAS PANELS

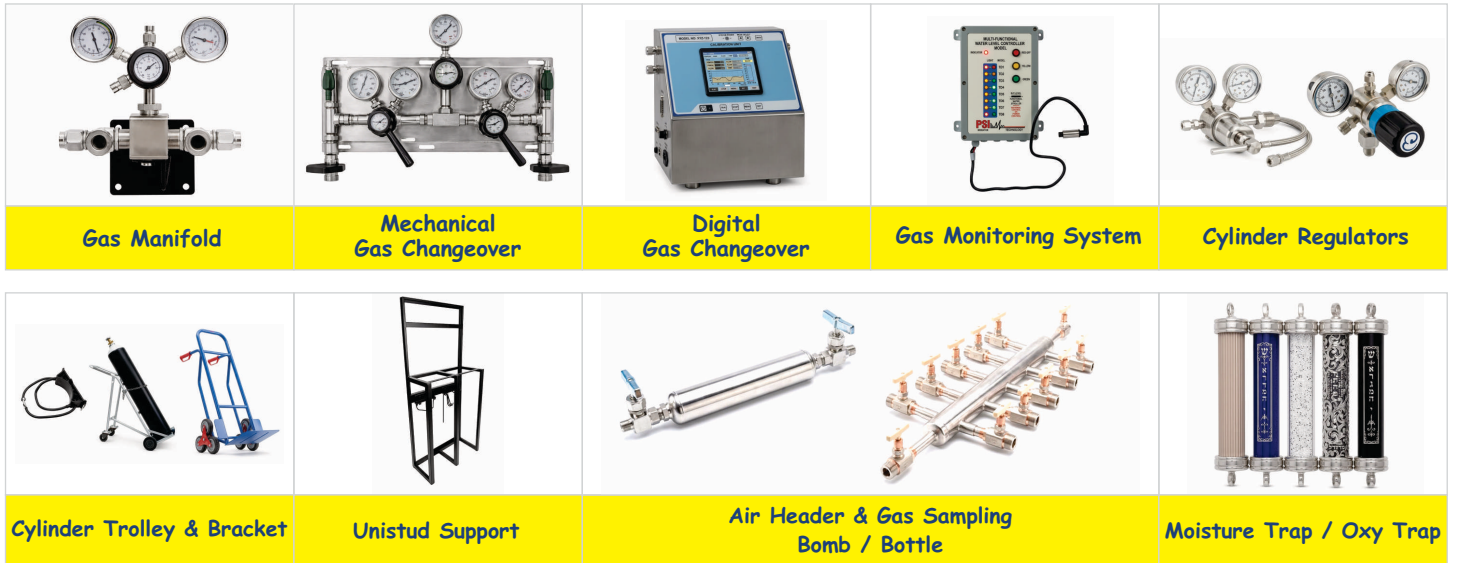

GAS PURIFICATION & CONTROL PANEL FOR AAS

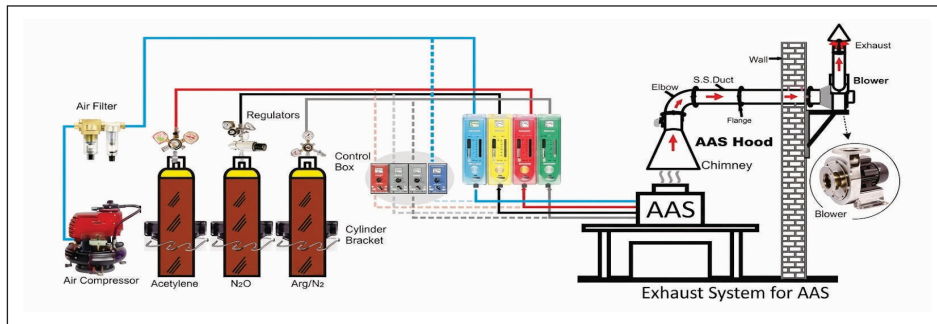

GAS DETECTION SYSTEMS

Gas Transmitter / Detector

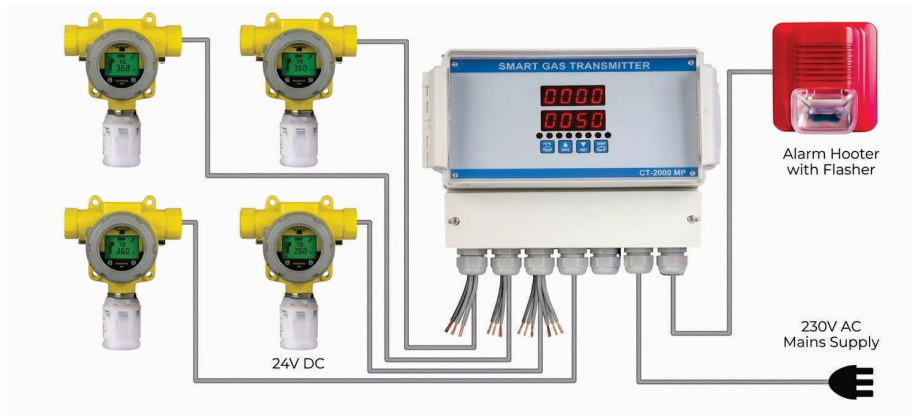

ULTRAPURE GAS GENERATORS

- Nitrogen Generator for LCMS, Turbo Evaporator, SPE
- Nitrogen Generator for LC /MS / MS
- Zero Air Generator for GC / TOC
- 3 in 1 Combination Generator (N, H, ZA)

Salient Features:

- Deliver constant pressure & flow
- Fully automatic programmable system
- Easy maintenance and space saving
- Improves instrument performance



Gas Generator
for LCMS



Wall Mounting
Generator for LCMS



Nitrogen Generator



Nitrogen
Generator



3 in 1 Gas
Generator



Zero Air
Generator



Zero Air
Generator



High Capacity Nitrogen Generator

GAS PIPING & UTILITY PROJECTS

Shreyal Medico Lab industries is a leading manufacturer and supplier of state-of-the-art gas handling and control systems. We specialize in designing, supplying, installing, and commissioning turnkey projects for a wide range of laboratories, including pharmaceutical, chemical, petroleum, food, and pesticide industries.

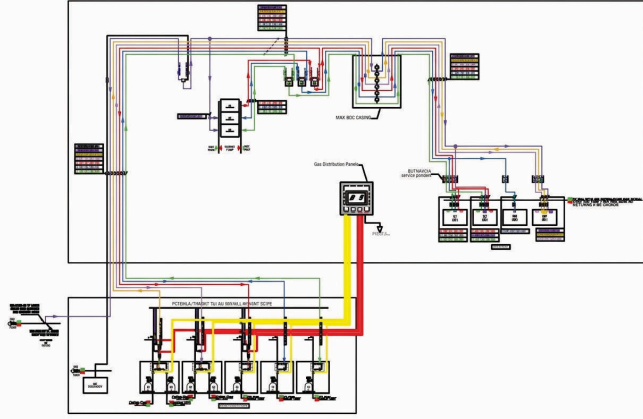

- Supply & Installation of Gas Piping & Utility Project
- Gas Detection System
- Low Gas Alarm Panel System
- HPLC Drain System
- Gas Cabinete & Gas Bank Shed
- AAS & ICP Ducting & Exhaust
- Gas Cylinder Automation
- Gas Cabinet & Cylinder Shed



FITTING & VALVES



Change Over Panel



Regulators



Valve & Micron Filter



Flexible Hoses



Tube & Pipe Fittings

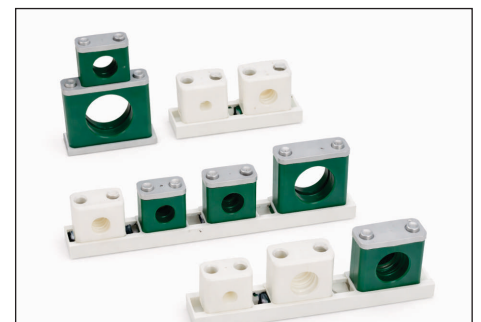

Clamp / Support / Tagging

ULTRASONIC BATH (SONICATOR)



Ultrasonic Bath



Ultrasonic Bath with Chiller



Sonoshaker

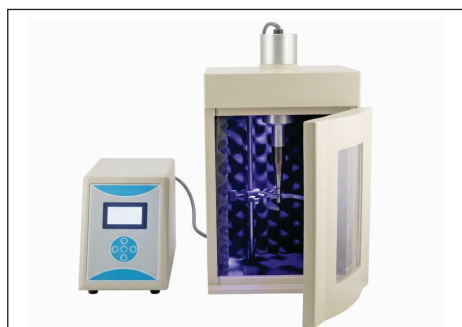

Probe Sonicator (Advanced)

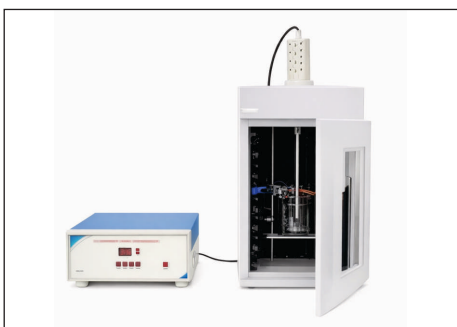

Probe Sonicator



Ultrasonic Performance Meter

DISSOLUTION MEDIA DEGASSER



Advance Dissolution Media Degasser

DIGITAL GAS FLOW METERS



DFM-05



SMLIMate-200

IR / FTIR ACCESSORIES



Manual Hydraulic Press



Mini Hydraulic Press



Automatic Hydraulic Press

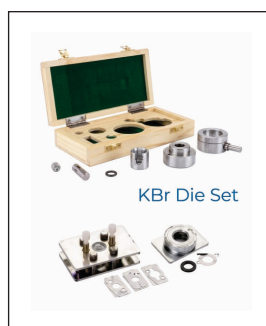

Universal Liquid Cell Holder

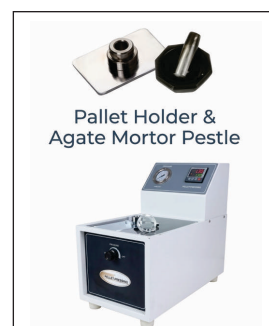

Pallet Holder & Agate Mortar Pestle

Dry Box

OIL FREE VACUUM PUMPS



SMLI



SMLI-30



SMLI-60



ROCKER-300

HPLC COLUMN OVENS



MODEL : HCO-002



MODEL : HCO-004



3 Branch Model : STU-3B



Multi-Fold Solvent Filtration System

ANALYTICAL EQUIPMENTS & ATTACHMENTS



Water Purification System



Recirculation Water Chiller



Nitrogen Concentrator 50



Nitrogen Concentrator 100



Water Purification System



Recirculation Water Chiller



Nitrogen Concentrator 100



LCP 100

HPLC COLUMNS STORAGE UNITS & Also Available in ABS

(Column Safety Cabinets)



(Column Safety Cabinet)

CSC 5



CSC 50



CSC 100 / CSC 200
CSC 250 / CSC 500 / CSC 1000



CSC 120P

CHROMATOGRAPHY CONSUMABLES



2 ml / 1.8 ml Screw Top Vials with Black Screw Cap & PTFE Septa (8 mm)



2 ml / 1.8 ml Crimp Top Vials with 11 mm Aluminium Crimp Caps & Septa



15 ml Screw Top Vials with Blue Screw Cap & PTFE Septa (9 mm) Bonded/Non-Bonded



20 ml Vials with 20 mm Aluminium / Magnetic / Bimetallic Crimp Caps & Septa



1 ml Shell Vial with Snap Plug



PP Vial with Cap & Septa



Vial Rack



Vial Insert & Syringes (GC/HPLC) Hamilton, SGE & Exmire

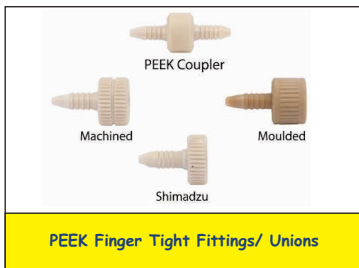

PEEK Finger Tight Fittings/ Unions

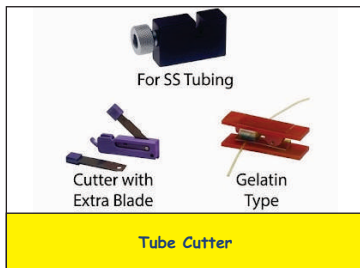

Tube Cutter



Crimper / Decrimper (Manual & Advanced)



PEEK / SS Tubing

CHROMATOGRAPHY CONSUMABLES



Syringes



GC Capillary Columns



Septas



Ferrules

CHROMATOGRAPHY CONSUMABLES



Pconlab Syringe Filters



Solvent Safety Caps



HPLC Solvent Waste Kit



HPLC Solvent Waste Safety System

CHROMATOGRAPHY CONSUMABLES

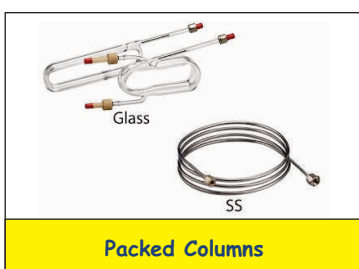

Packed Columns



GC Septas Silicon Rubber / Teflon Coated



Ferrules (Teflon/Graphite)



Column Adapters

CHROMATOGRAPHY CONSUMABLES

Solvent Filtration Kit	Mobile Phase Filters	Pre Column Filter Holder & Frit	PEEK / SS Tubing
SS Fittings	Rheodyne Injector	Cuvettes-Quartz / Glass	D2 / Hollow Cathode Lamp

CHROMATOGRAPHY CONSUMABLES

Pconlab Syringe Filters

CHROMATOGRAPHY CONSUMABLES

Pconlab Syringe Filters





MAPPLE

TECHNOLOGY PVT. LTD.

 Info@mappletechnology.com

 www.Mappletechnology.in

13, 5th Floor B1, Building C-39 A, TTC Industrial Area, MIDC Industrial Area, Pawne, Navi Mumbai,
Maharashtra - 400705.